RACK LOCK MANUAL

INSTALLATION • MAINTENANCE • PARTS



PHONE 800 448 8979
FAX 800 236 8722
WEBSITE WWW.TRACRITE.COM
EMAIL TR@TRACRITE.COM
ADDRESS 314 WILBURN ROAD
SUN PRAIRIE, WI 53590



This manual MUST be left with the owner

Thank you for purchasing Trac-Rite's Rack-Lock pallet security system. The following is an instructional guide to take you through the steps of installing your product. Be sure to read and understand this entire installation manual including the warnings, cautions, and notes before starting the installation of your new Rack Lock system.

The following terms are defined as:

WARNING - serious personal injury or death can result from failure to follow instructions.

CAUTION - minor injury or property damage can result from failure to follow instructions.

NOTE - special attention should be given.



WARNING

Rolling steel doors are large, heavy objects that move with the help of springs under extreme tension. Since moving objects and springs under tension can cause injuries, your safety and the safety of others depends on you reading and following the instructions in this manual. Check your work prior to operating door.

POTENTIAL HAZARD	EFFECT	PREVENTION
MOVING DOOR	Can Cause Serious Injury or Death	Keep people clear of opening while door is moving. Get help or use support when lifting new door into place.
EXTREME SPRING TENSION	Can Cause Serious Injury or Death	Installation, repairs, and adjustments must be made per the instructions provided by Trac-Rite. Before winding torsion spring, make sure door is fully open and curtain is wrapped on barrel. Spring repair/replacement should be performed only by a qualified door mechanic.



WARNING

Components under extreme spring tension can cause **SERIOUS INJURY** or **DEATH**. Adjustments and repairs must be made by a qualified door mechanic using proper tools and instructions. Do **NOT** attempt to adjust door tension unless the door is in the "UP" position. Winding bar should be solid steel 1/2" diameter rod or 3/8" x 1/2" flat.



CAUTION

Spring Tension is Critical: Improper tensioning of the spring(s) can result in door damage and reduce the life of your door. The door should not slam up or down during operation. No warranty claims will be honored due to damage caused by improperly tensioned spring(s).

Proprietary Notice

Information contained in this document is copyrighted by Trac-Rite and may not be duplicated in full or part by any person without prior written approval of Trac-Rite. Its purpose is to provide the user with adequate detailed documentation to efficiently install a Rack-Lock pallet security system.

For Customer Support:

Please Call: 1-800-448-8979 ext. 3214

INSPECTION:

Door and Hardware: Upon receiving the door shipment, immediately inspect the door and hardware for damage. Verify the product received with the packing list. Damage and/or shortages should be reported immediately to Trac-Rite customer service at 800-448-8979, ext. 3214. Please have your bill of lading and packing list to reference when reporting shortages or damage. Do not install damaged material without authorization from Trac-Rite.

PREPARATION:

Clean the work area. Remove all debris and sharp objects from the area where the door will be placed on the floor. Sweep the area clean. It is also recommended that the door curtain assembly be placed on a piece of cloth or cardboard to help ensure that the finished door surfaces will not be damaged while the door is being prepared for installation.

RECOMMENDED TOOLS FOR ASSEMBLY:

- Wrenches or sockets 7/16" and 1/2" sizes
- Drill or screw gun
- #2 square drive bit, min of 4" long
- 3/8" drill bit
- 1/2" drill bit
- C-clamps or vise grips
- Pliers
- Standard wrenches
- Mallet
- Safety glasses
- Work gloves
- Pliers
- Tape measure
- Marker
- Tin snips
- 2' level
- Appropriate height ladder(s)

PARTS LIST

Some component part numbers contain a color or length code which varies by order. In the part numbers below, YY represents a color code, while XXXXX represents a length or height code (for example 07200 signals a 72" part).









Corner jambs	96604XXXXX
Midbay jambs	96606XXXXX
Double jambs	96605XXXXX
Upper door mount - right	966100002
Upper door mount - left	966100001
Lower door mounts - right	966100004

Lower door mounts - left	966100003	Door keepers	502592
Guide - right	96601XXXXX	Door bracket - right	9661000006
Guide - left	96602XXXXX	Door bracket - left	9661000005
Header	96603XXXXX	Handle	502589
Security corner trim	96609XXXXX	Plastic pull	502585
Security side/back panel	28YXXXXX	Rope	508840
Door nest	(part # varies)	Washers	506613
Door stops	502594		

NOTE

The fastener kit is designed to work with multiple products, therefore you may receive unneeded fasteners. Be sure to use only the fasteners specified in each step of these instructions.

INCLUDED FASTENERS

ACTUAL SIZE PHOTO	DESCRIPTION AND PART NUMBER	TYPICALLY USED FOR
	Security bolts, 4" long 966100007	Corner jamb to pallet rack connection
	Security nut 966100015	Corner jamb to pallet rack connection
	Hex head bolt and nut 1/2" x 4" 9661000008 bolt 9661000009 nut	Fastens door mounts to pallet rack
	Self-drilling screw 1/4 - 14 x 7/8" (hex drive) 502845	General fastening where security feature is not needed
	Self-drilling tek screw #10 - 16 x 3/4" (sq drive) 9661000011	Fastens security panels, door guides, jambs and center trims
	Track bolt and whizlock nut 5/16 - 18 x 3/4" 502961 bolt, 625053 nut	Fastens guide to door mount and door stops to bracket
	Track bolt and whizlock nut 1/4 - 20 x 3/4" 502882 bolt, 502910 nut	Fastens keeper and door handle to bottom bar
	Cotter pin 3/16" x 2" 502960	Secures door axle to door brackets

800-448-8979

PALLET RACK ASSEMBLY:

Assemble the pallet rack per the rack manufacturer's instructions, installing any adjustable shelving supports at the desired height. Leave any shelves out to allow for room to work inside the unit. If the optional roof kit will be installed, a set of cross arms must be installed the upper most position in the front and back of the rack.

1. Position the door in front of the rack, oriented in the position as shown as to unroll into the guides when assembled. Locate the door brackets, upper mounts, two 5/16 - 18 track bolts, matching nuts, large washers, and cotter pins.

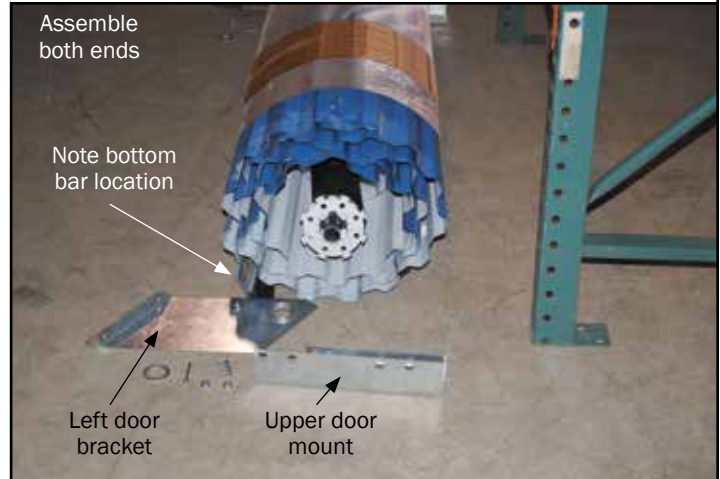
**MOTOR INSTALLATION**

If you will be installing the motor operator on this unit. Install the sprocket on the "motor" side of the door at before installing the cotter pin. Refer to details in the rear of this manual for motor installation.

2. Slide the door brackets over the axle. Add a large washer if space allows, and secure with a cotter pin.



3. Attach the upper mounts to the door brackets using two 5/16 - 18 track bolts.



NOTE

The RIGHT/LEFT markings on the brackets refer to the perspective of standing inside the storage space or pallet rack and looking out through the door opening.



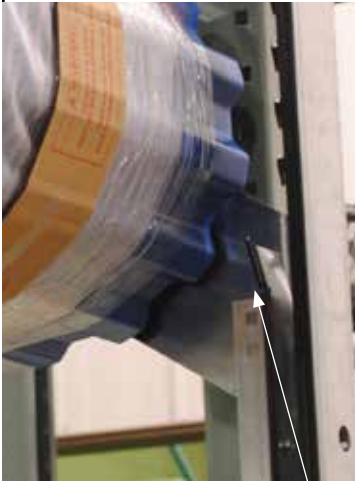

Bottom edge of guide flare aligns with bottom of notch in door mount

4. To determine the installation height of the door nest, hold a guide up to the pallet rack. Mark the height at which the top of the inside of the guide is punched or bent to flare into the unit. The bottom of the notch (called out in next step's illustration) on the door mount should be located as close as possible to this point on the guide. Mark the position of the bottom of the door mount on the pallet rack. Lift the door assembly into the rack, and position under the top cross arm of the pallet rack.



Bottom edge of notch on bracket

5. Align the holes on the upper mounts with a set of holes in the rack and loosely secure with **two 4" hex bolts and nuts per mount.** These bolts will be tightened further in step #14. The bottom of the door mount should be above the mark made on the pallet rack in step #4.



Select a mount height to line up with two of the three holes.



6. Select height for the lower mounts that intersects with two of the three holes in the guides and does not interfere with the location where you wish to install the lowest shelf support. Fasten the lower mounts to the rack frame with **two 4" hex bolts and nuts per mount.**

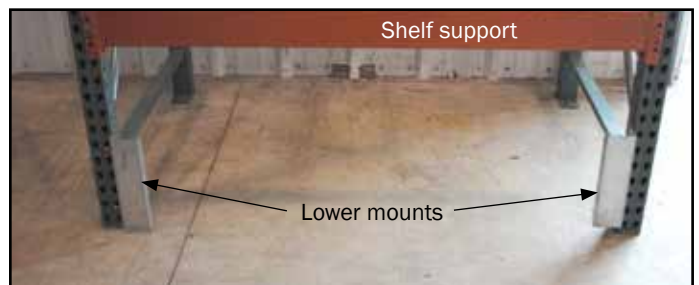

Shelf support

Lower mounts

7. To prepare the door guides for installation, bend the lead-in tab at the top of the guide to protrude approximately 3/4". (see illustration for step 10)

Position the guides so that the door curtain will have 1/4" free play on each side. Positioning the guide flares to fit within the notches of the door mounts should achieve this. Install the door guides, fastening to the top mount, securing with only one tek screw. Tek screws should be driven through the back of the door guide. Access the back of the door guide is provided through pre punched holes in the front.



502845



8. Locate the keepers, door stops, and fasteners, as well as 1/2" and 7/16" wrenches in preparation to tension the door.

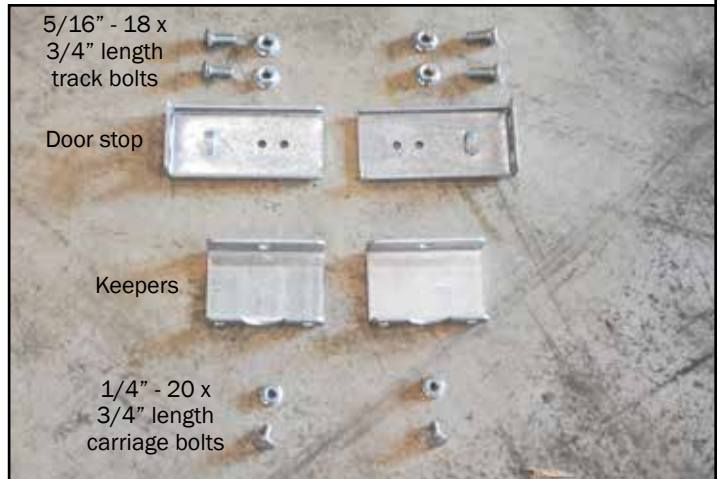

WARNING

Care must be taken to secure door so it does not spin around free, as this may cause personal injuries and damage to door curtain. Door is free to spin until door stops and keepers are installed.

9. Add tension to the door springs by rotating the door two times in a "closing" direction. Hold the door tightly until stops and keepers are installed.





10. Holding the door securely so that it does not unwind, remove packaging and feed the door into the guides. The top edges of the guides should be bent into the rack to allow for smooth operation.

NOTE!

DO NOT REMOVE WHITE FELT TAPE on the inside of the door curtain. It is a door component, **NOT** packing material.



WARNING

Immediately install keepers and door stops. These devices will prevent the door from rolling up out of the guides and possibly causing injury.

11. Fasten the door stops to the upper mounts using two 5/16" - 18 track bolts on each side.



12. Attach door keepers to each end of the door's bottom bar using the 1/4" - 20 carriage bolts.



NOTE

The door tension may now be adjusted for best operation. The inside rear cover of this manual contains further tensioning detail.

13. Adjust the guides as needed to maintain equal play on each side (approximately 1/4" space), then fasten the guides to the lower mounts through the two access holes intersecting the lower mounts.



502845

14. Tighten the loosely installed bolts from step #5 connecting the upper mounts to the rack. (not pictured here - see step #5.)



MOTOR INSTALLATION

If you will be installing the motor operator on this unit. Install the mounting bracket and motor at this time. Refer to details in the rear of this manual for motor installation.

15. The latch side jamb must be notched to allow room for the latch to slide closed. Measure from the floor to the bottom of the latch opening on the guide. In configurations with a mid bay or center jamb(s), the notch will need to be created on those jambs with adjacent doors.



16. Identify which end of the jamb will be on the floor, and transfer the measurement from the floor.

17. Starting with this measurement, mark an area on the smaller flange 2" tall by 1 1/2" wide.





18. Cut the upper and lower extents of the area, and fold the flap inward or cut it out entirely.

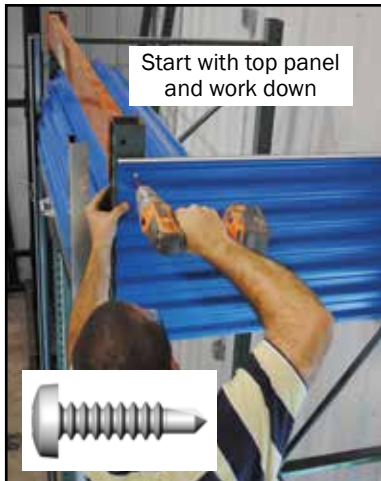

19. If Trac-Rite's optional side and back of rack closure system or other side closure material will be installed, add it at this time. *If not skip to step 20.*

19.1. To install Trac-Rite's optional ribbed panels, total the height of all 20" panels that will be installed, plus one inch, and mark this height on the side of the rack. For example, a 12' tall rack uses seven 20" panels. $(7 \times 20) + 1 = 141$ inch height.

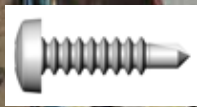

19.2. Position the upper edge of the **top panel** at the mark, with the hook of the bottom hem facing into the rack. Check for level and fasten to the rack through the upper corners of the panels with square head tek screws.



19.3. Hang the remaining panels using the "hooks" but do not fasten yet. Slide them in to place from the side. With all panels in place, the bottom edge should hang just above the floor.

Hang panels on hooks, no fasteners yet

19.4. Pull the bottom edge of the bottom panel tight to the floor and fasten at the lower corners. Add additional fasteners, **2-4 per panel**, to secure the remainder of the panels to the rack.



19.5 If side panels are used to separate a secure rack from an unsecure rack, fasten the panels with tek screws to the interior of the secure rack. Use a tin snips to create notches for the rack's horizontal supports. Use **2-4 screws per panel**.



20. Position the corner jamb, with the notched flange lined up to the door latch cutout on the guide.

21. Locate the pilot holes inside the door guides against the jambs, and fasten all but the top 2' using tek screws - the top will be fastened after the header is installed in step 25.





22. If multiple bays are to be enclosed with the Rack-Lock system, install neighboring rack mounts, door and guides. Center jambs may then be installed between the guides of the adjacent racks. Fasten with tek screws through the pre-punched holes within the guides. Notch the center jambs for door latch clearance as was done with the side jamb in steps 15-18.

If your configuration includes mid-bay jambs (used when joined racks contain multiple height rack lock enclosures), they may be installed at this time using the same technique as a center jamb.



23. Headers may be installed after jambs are installed on both sides of a door opening. Slide the header into the gap between the guides and jambs. Secure it with tek screws from both above and below the header. Install tek screws in the remaining guide holes to fasten the guide to the jamb.



24. To install the corner jamb security bolts, 1/2" holes must be drilled. Select locations approximately 1-2' from the top and bottom of the rack, and insert the drill bit through the rack to drill through the corner jamb.

25. Insert a security bolt through the hole from the exterior, and secure with a flange nut in the interior.

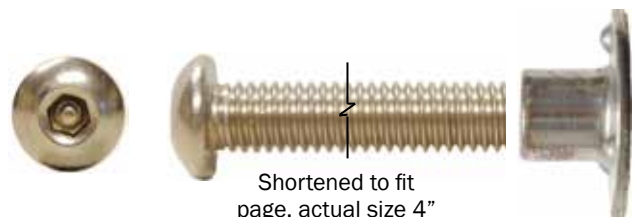

Shortened to fit page, actual size 4" thread.

26. If your system includes back panels, install them using the same procedure as the side panels. **Use 4 screws per panel.**



27. Position and fasten the security corner trims (included with the optional side and back of rack closure system). Tek screws may be used as a temporary fastener. For a permanent and more secure attachment, install security bolts as was done during corner jamb installation (step #24).

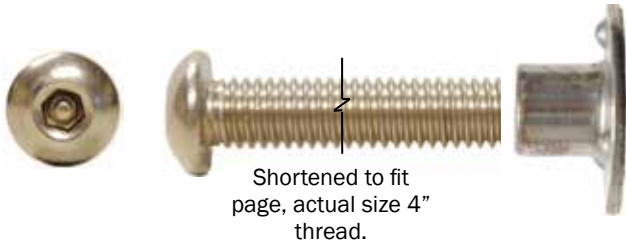



OPTIONAL ROOF ASSEMBLY:

The roof assembly should be installed AFTER the door, header, jambs, side and back panels. If a motor operator is to be used, install it first as well.

1. The roof supports should be oriented as shown, and may be installed so that the low side is at either the front or rear of the rack. The roof support length should match the width of the pallet rack. If the supports are longer, trim them.



2. Position and attach the low side roof support. Fasten with self drilling tek screws (approximately one per foot) on the back side, NOT the top.



508310
1/4-14x1"



3. Position and attach the high side roof support. Fasten to the cross arm with self drilling tek screws, using an extension on your screw gun to drive the screws through the access holes on the top of the channel (approximately one per foot).



508310
1/4-14x1"

4. Place the low side flashing on top of the cross arm on the back side of the rack. Position so that the lower leg overlaps the back panel material. Fasten the vertical leg with self drilling hex head tek screws (approximately one per foot). The fasteners for the roof panels will go through the flashing and into the rack's top cross arm.



508310
1/4-14x1"

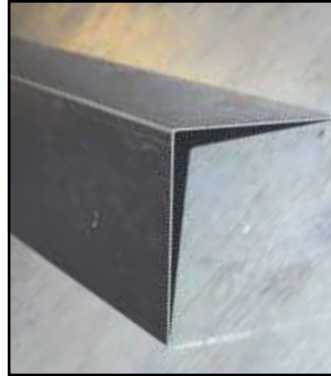

low side flashing
96615xxxx



low side flashing



foam closure

5. Position the first roof panel in place, **with foam closures under the low side**. The high side of the panel should extend beyond the high side roof support to be even with the header or panel below it. The side of the roof panel should extend to the same plane as the outer edges of the side panel material. Orient the panel as shown, so that the "hook" of the panel seam faces up where the next panel will mate.

Fasten the panel using the color matched rubber washer screws using **4 screws per panel**. Before adding the next panel, add a thick bead of caulk in the hook of the seam. Additionally, drive **one security screw** through the low side of each roof panel, into the roof support.



4 screws per panel

Roof Screw - 5/16"ZAC
washer head 1.25"long

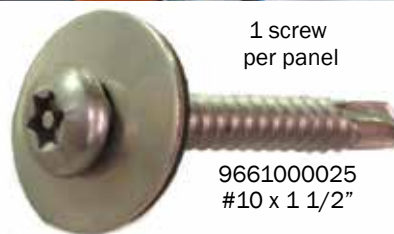

1 screw
per panel

9661000025
#10 x 1 1/2"

6. The final panel must be trimmed to size. Measure the remaining distance, and cut a panel to fit the space. Fasten the final panel in to place. Cut the panel so that you still have the correct seam to mate to the adjoining panel.



Roof Screw - 5/16"ZAC
washer head 1.25"long



Roof Screw Part Numbers

- | | |
|--------------------|---------------------------|
| Iced White: 104173 | Continental Brown: 104053 |
| Garnet: 710970 | Sunset Orange: 104055 |
| Polar Blue: 104049 | Evergreen: 104089 |
| Royal Blue: 104011 | Cedar Red: 104134 |
| Desert Tan: 104051 | Zinc Plated: 710977 |



7. To prepare for side trim installation, run a bead of caulk on top of the inner most ridge that the side trims will cover entirely.



8. Position the side trims in place, and fasten with **four screws** on the top into the same ridge where caulk was applied using the washer head security screws and provided driver bit. Using a bit with a sliding holder (included with bit, kit part #9661000030) will make it easier to use the security screws.



9661000025
#10 x 1 1/2"

Side trims
966131xxx, 966132xxx



9. Using a location with an existing hole in the rack if possible, drill a 1/2" hole for the security bolt at each side of each side trim. Install one security bolt and nut at each corner. *Note: rack side panels should be installed already - not shown in photo.*

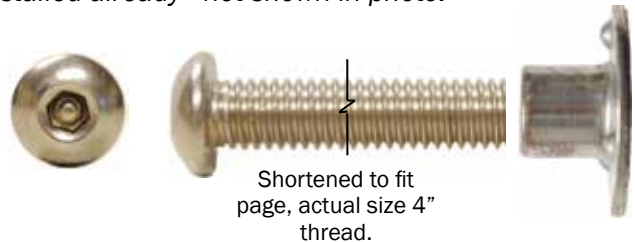

Shortened to fit
page, actual size 4"
thread.

10. Install the high side trim, using foam closures between the roof panel and trim to reduce dust infiltration. Use approximately one screw per foot.



9661000025
#10 x 1 1/2"



96614xxxx



11. Fasten the front trim using washer head security screws across the top, fastening into high ribs, and screws across the lower front edge. For a neater appearance, locate the front screws at a consistent height. Use approximately one screw per foot.



9661000025
#10 x 1 1/2"



12. Depending on your rack configuration, rectangular and/or triangular fillers may be used to plug the holes in the upper front corners. Insert fillers into the corner holes and fasten with two washer head security screws per cap.



9661000037/ 9661000038
midbay filler



9661000035/ 9661000036
end corner filler





MOTOR OPERATOR INSTALLATION:

1. Install the sprocket in the end of the door which will receive the motor. The motor may be installed on either side on doors with two springs. On doors with only one spring, we recommend installing the operator on the spring side. Secure with the provided screw (supplied in the motor operator box) through the hole used for the cotter pin on a non-motorized door.

NOTE

The **RIGHT/LEFT** refers to the perspective of standing inside the storage space or pallet rack and looking out through the door opening. The photos here depict a **RIGHT** side motor installation

Measure to use the existing pallet rack holes to install tube



2. Measure the distance from the holes in the rear rack upright to the holes in the front upright. Cut the square tube section to a length 2" greater than this measurement.

The tube will be installed on the side of the pallet rack to support the motor.



Motor support tube

Drill 1/2" holes through the square tube, one inch from each end. Using 6" hex bolts and nuts, loosely fasten the tube to the interior of the rack, just above the fastener on the bottom of the door mount. Fasten the rear of the tube to the rear rack upright, and tighten both ends.



Bolt 9661000042 Actual length approx 6"
Nut 9661000009

3. Before fastening the mounting bracket and drive gear to the motor, verify the correct orientation of the parts, as illustrated.



Drive sprocket not shown, install on this side.

LEFT mount orientation



RIGHT mount orientation

4. Secure the motor to the mounting bracket using two fasteners per tab. Install the drive sprocket on the driveshaft, secure using the provided set screw.



5. Fully open the roll up door. Position the motor assembly on the support tube as shown. In most cases, the chain may be used without removing links - locate the motor on the tube support just far enough back to allow approximately 1/2" of slack in the chain. Using two tek screws, fasten the bracket to the tube through the center of the slotted holes. The slotted holes allow for adjustment in the chain slack. Tighten screws and install screws in the remaining slots to prevent the motor from sliding back.

Make sure that the door nest will not rub the motor.



6. Install key or button switches and program wireless remotes per the motor operator instructions.

		HEIGHT	
		7' 0"	10' 4"
WIDTH	up to:		
	3' 0"		
	3' 11"	3	
	4' 6"		
	5' 0"	4	
	5' 1"	2	
	7' 11"		
	8' 0"	3	3
	9' 0"		
	10' 8"	2	

Spring Tension (Number of turns)

Figure 5

NOTE!

When installing multiple doors of the same size, confirm the first door is operates correctly and is properly tensioned and apply the same tensioning method to all doors.



WARNING

Care must be taken to secure door so it does not spin around free, as this may cause personal injuries and damage to door curtain. Door is free to spin until door stops and keepers are installed.

DOOR TENSIONING:

Determine the proper number of nest rotations needed to tension the door, based on the door size (See *Figure 5*). Rotate the nest towards the door opening the appropriate number of turns to tension the system (See *Figure 6*).

Hold the door tightly to prevent unwinding. Remove the stretch wrap and cardboard strips wrapped around the door curtain and discard.

Guide the door curtain carefully into the door guides and pull it down to approximately waist level.

Hold the door in position until the door stops and keepers are installed.

ADJUSTING DOOR SPRING TENSION

A properly tensioned door should be balanced (does not fall closed or spring open) when opened to waist level. Step on the handle to close door fully.

To add tension, insert winding bar in the rectangular hole in the tension wheel and pull down until ratchet clicks. Move up slightly until ratchet locks in place (See *Figure 12*). If more tension is needed, move winding bar to the next hole in the tension wheel and repeat as necessary.

To remove tension, insert winding bar into tension wheel and move down 1" to unlock ratchet. Push the tension lock pin toward wall and raise winding bar 2". Release tension lock pin. Move up 1/8 turn until the ratchet locks in place.

If door has two tensioners be sure to equally add or remove tension to each side of door.

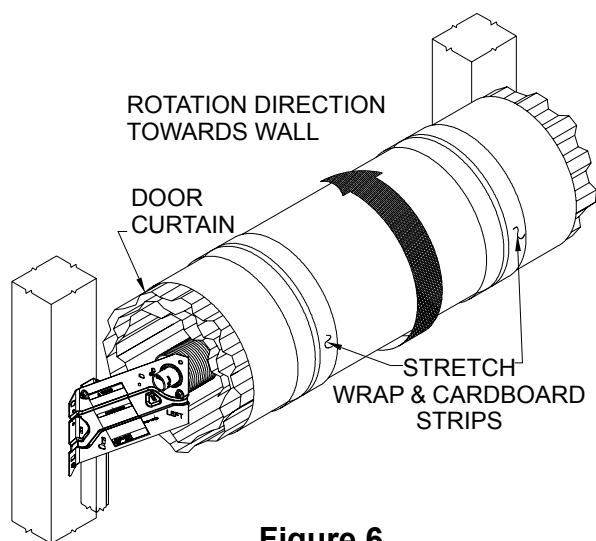

Figure 6

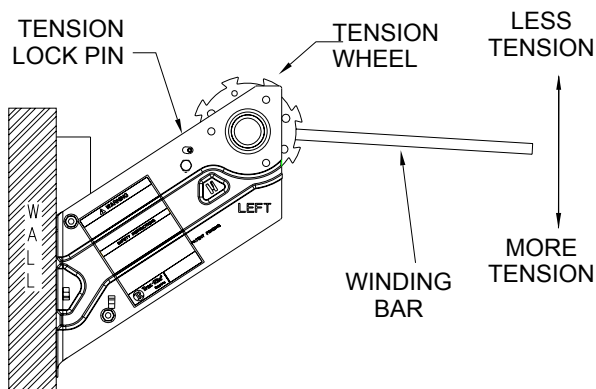

Figure 12

